

## 1、产品概要 / Outline

- ◆ 磁屏蔽结构，有较强抗干扰性能
- ◆ 正方形构造适合高密度贴装
- ◆ 耐大电流低阻值
- ◆ 工作温度：-40℃~+125℃
- ◆ 主要应用于照明行业、通信设备、计算机行业、安防行业、
- ◆ 智能家居行业、家用电器、电子产品等

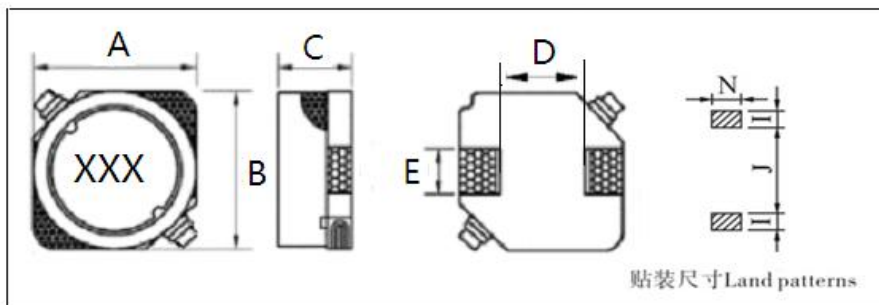

## ◆ 2、外观尺寸/ Appearance size 单位:mm

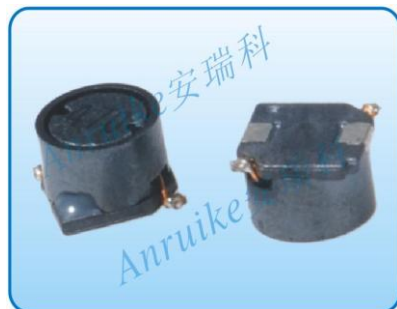

A	B	C	D	E	N	I	J
12.0±0.3	12.0±0.3	7.5±0.3	8.6	3.2	3.2	2.5	8.6

## 3、电气特性/Electrical characteristics

型号/NO	L/uH	DCR ( Ω )	Isat(A)	Irms(A)
ADBL1275-3R3M	3.3	0.010	9.50	13.0
ADBL1275-4R7M	4.7	0.011	8.30	11.2
ADBL1275-5R6M	5.6	0.012	7.80	10.2
ADBL1275-6R8M	6.8	0.013	7.20	9.5
ADBL1275-100M	10	0.016	5.50	7.6
ADBL1275-120M	12	0.017	5.10	7.0
ADBL1275-150M	15	0.018	4.70	6.5
ADBL1275-220M	22	0.026	4.40	6.0
ADBL1275-330M	33	0.040	3.20	5.6
ADBL1275-470M	47	0.053	2.70	5.0
ADBL1275-101M	100	0.125	1.90	4.7
ADBL1275-151M	150	0.175	1.50	4.0
ADBL1275-221M	220	0.258	1.30	3.4
ADBL1275-331M	330	0.280	1.20	2.8
ADBL1275-471M	470	0.300	1.10	2.0

- ◆ K 表示电感值的公差为±10%，M 表示电感值的公差为±20%，N 表示电感值的公差为±30%
- ◆ K said inductance tolerance is ±10%, M said inductance tolerance is ± 20%
- ◆ 所有数据基于环境温度 25℃条件下测试
- ◆ All data is based on testing at an ambient temperature of 25 °C

- ◆ 测试条件 : 100KHz/0.25V
- ◆ 本页面未能录入全部或最新的数据, 请您在订购前向本公司咨询精准参数及样品。
- ◆ We were unable to input all or the latest data on this page. Please consult our company for accurate parameters and samples before placing an order.

## 4 包装规格/ Packaging specifications 单位/mm

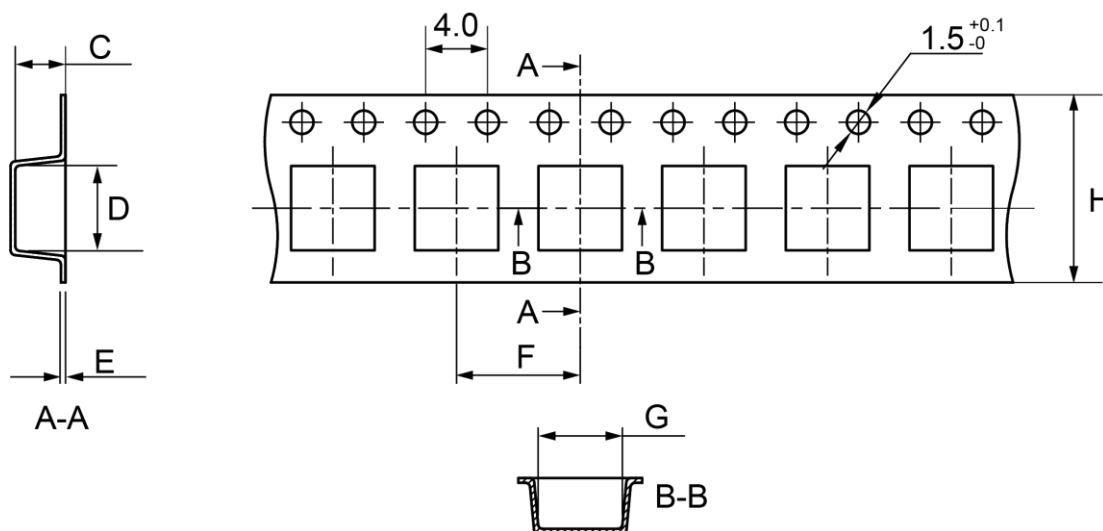

型号	C	D	E	F	G	H
ADBL0735	3.65±0.1	7.7±0.1	0.35±0.05	12.0±0.1	7.7±0.1	16.0±0.3
ADBL0750	4.8±0.1	7.8±0.1	0.35±0.05	12.0±0.1	7.8±0.1	16.0±0.3
ADBL1045	4.75±0.1	10.8±0.1	0.35±0.05	16.0±0.1	10.8±0.1	24.0±0.3
ADBL1270	8.1±0.1	12.8±0.1	0.35±0.05	16.0±0.1	12.8±0.1	24.0±0.3

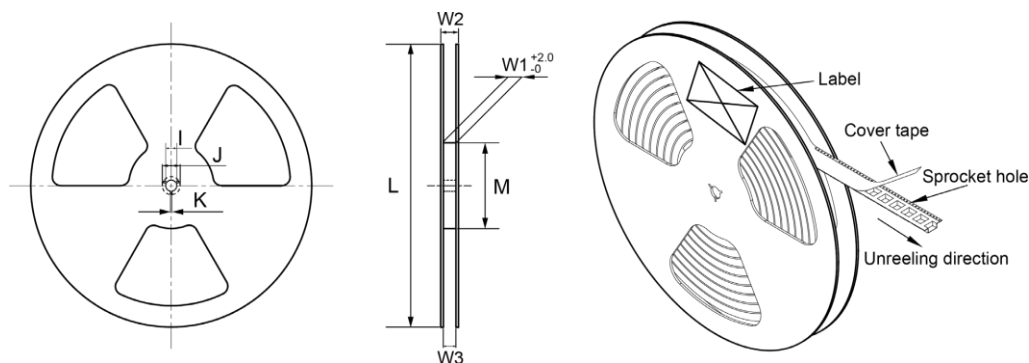
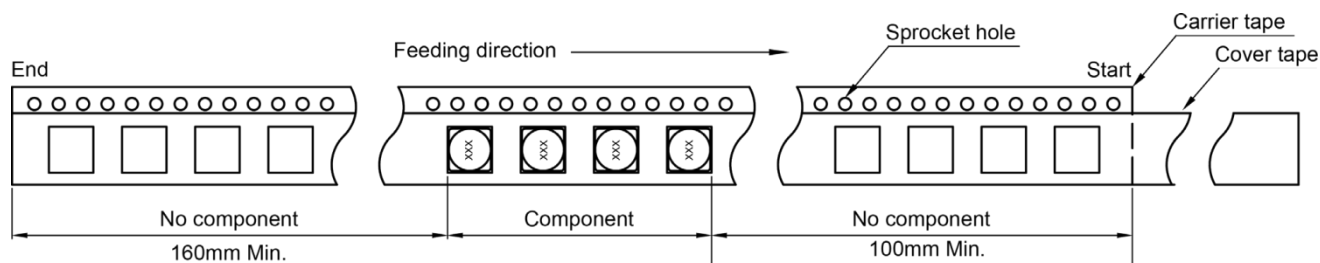

型号	数量	I	J	K	L	M	W1	W2	W3
ADBL0735	1000pcs	13.0±0.5	21.0±0.8	2.0±0.5	330±2.0	100Min.	16.4	22.40Max	15.90Min
ADBL0750	1000pcs	13.0±0.5	21.0±0.8	2.0±0.5	330±2.0	100Min.	16.4	22.40Max	15.90Min
ADBL1045	800pcs	13.0±0.5	21.0±0.8	2.0±0.5	330±2.0	100Min.	24.4	30.40Max.	23.90Min.
ADBL1270	500pcs	13.0±0.5	21.0±0.8	2.0±0.5	330±2.0	100Min.	16.4	22.40Max.	15.90Min.

5、焊接/welding

• 焊接原材料 Soldering Materials

(a) 焊料：推荐使用 96.5Sn/3.0Ag/0.5Cu 焊料，或者采用 Sn 含量不超过 97%的锡合金焊料。Solder: It is recommended to use 96.5Sn/3.0Ag/0.5Cu solder, or use Tin alloy solder with a Tin content not exceeding 97%.

(b) 助焊剂：推荐使用松香类助焊剂，请勿使用强酸性助焊剂（含氯量超过 0.2wt %），并且请勿使用水溶性助焊剂。

Flux: It is recommended to use rosin-based flux. Acidic flux (with chlorine content exceeding 0.2wt %) and water-soluble flux are forbidden.

• 焊接温度及要求 Soldering Temperature & Requirements

(1) 回流焊 Reflow Soldering

回流焊温度曲线 Reflow Soldering Temperature Profile

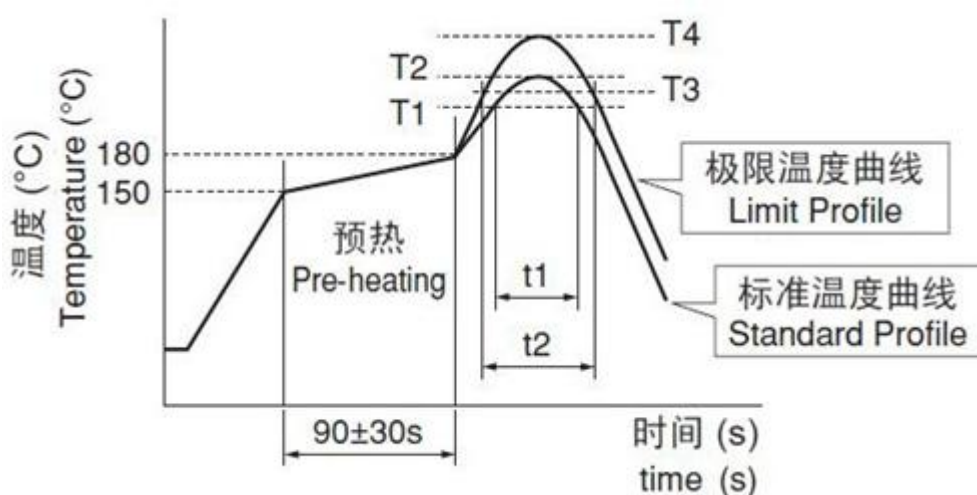

回流焊要求 Reflow Soldering Requirements

标准温度曲线Standard Profile				极限温度曲线Limit Profile			
加热Heating		峰值温度 Peak Temp. (T2)	回流焊 次Cycle Of Reflow	加热Heating		峰值温度 Peak Temp. (T4)	回流焊次数 Cycle Of Reflow
加热 Tem p. (T1)	时间 Time (t1)			温度 Temp. (T3)	时间 Time (t2)		
220°C	30~60s	245±3°C	≤2	230°C	≤60s	260°C/10s	1

## (2)、波峰焊 Flow Soldering

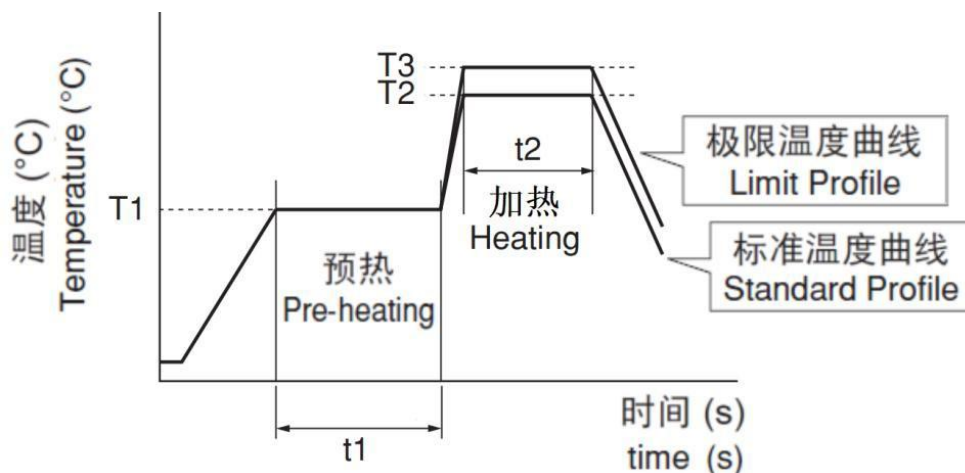

波峰焊要求 Flow Soldering Requirements

预热 Pre-heating		标准温度曲线 Standard Profile			极限温度曲线 Limit Profile		
		加热 Heating		波峰次数 Cycle Of Flow	加热		波峰次数 Cycle Of Flow
温度 Temp (T1)	时间 Time (t1)	温度 Temp (t2)	时间 Time (t2)		温度 Temp. (T3)	时间 Time (t2)	
150°C	≥60s	250°C	4s ~ 6s	≤2	265±3°C	≤5s	1

## 6、其他

- ◆ 本产品为无铅，请采用无铅环境作业
- ◆ Other: Our company's products are lead-free, please operate in a lead-free environment
- ◆ 由于页面限制，更多资料请联系我司
- ◆ Due to page limitations, please contact our company for more information
- ◆ 在过载电流等不正常条件下，本电感产品无自我保护功能。
- ◆ Under abnormal conditions such as overload current, this inductor product has no self-protection function.
- ◆ 贮藏温度：10°C ~ 25°C，相对湿度：65% ~ 85%。
- ◆ Storage temperature: 10 °C ~ 25 °C, relative humidity: 65% ~ 85%