

1、产品概要 / Outline

- ◆ 组合设计，坚固的结构
- ◆ 较大电感值，超级大电流
- ◆ 扁平线绕组，实现低直流电阻
- ◆ 温度上升电流和饱和电流受环境的影响较小
- ◆ 工作温度: -25°C ~ 125°C .
- ◆ 放置形式为 DIP
- ◆ 主要应用于大电流的工作环境，如充电桩、工业控制等

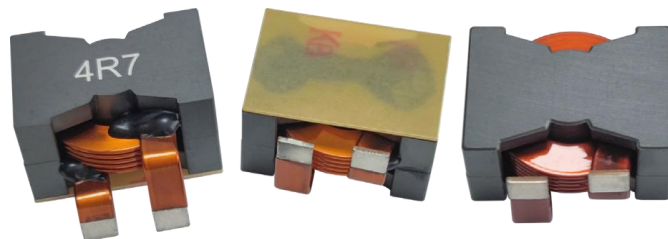

2、外观尺寸/ Appearance size 单位:mm

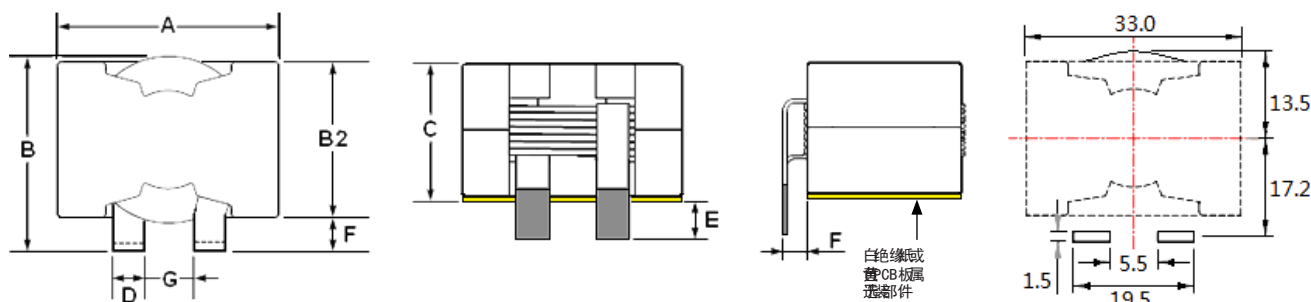

A	B	C	D	E	F	G
33.5 Max	30.8±1.0	25.5Max	6.0±0.3	3.5±1.0	6.7 Ref.	6.0±0.5

3、电气特性/Electrical characteristics

型号	L(0A)	DCR(mΩ)Max	Irms (Typ)	Isat (Typ)
DER3225-100M	10	2.3	47	50

注释

- ◆ K 表示电感值的公差为±10%，M 表示电感值的公差为±20%
- ◆ K said inductance tolerance is ±10%, M said inductance tolerance is ± 20%
- ◆ 所有数据基于环境温度 25°C条件下测试
- ◆ All data is based on testing at an ambient temperature of 25 °C
- ◆ 测试条件：100KHz/1.0V
- ◆ 本页面未能录入全部或最新的数据，请您在订购前向本公司咨询精准参数及样品。
- ◆ We were unable to input all or the latest data on this page. Please consult our company for accurate parameters and samples before placing an order.

4 包装规格/ Packaging specifications 单位/mm

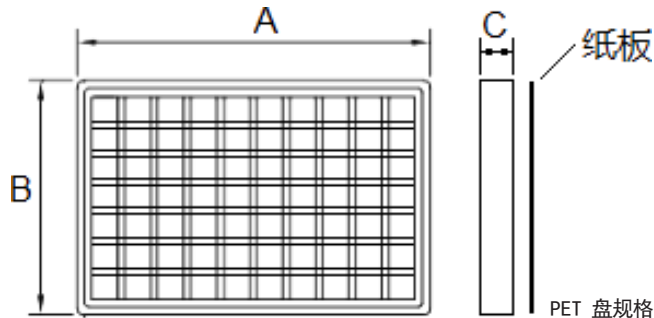

A(Ref.)	B(Ref.)	C(Ref.)
322	202	28

PET 盘规格: 322*202*28mm, 每盘装 28 个。

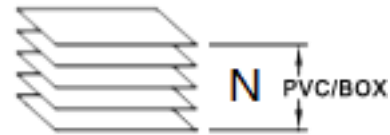
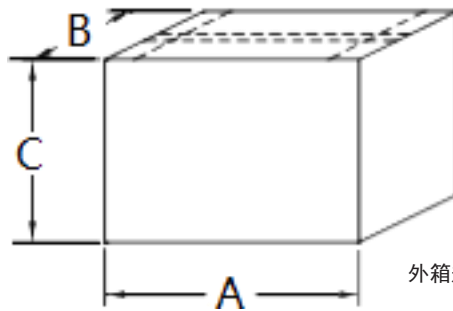

外箱规格: 340*215*220mm, 7PET 盘装一箱, 一箱装 196 个。

QTY (Pcs/Box)	A(Ref.)	B(Ref.)	C(Ref.)
196 Ref.	340	215	220

5、焊接/ welding

• 焊接原材料 Soldering Materials

(a) 焊料 :推荐使用 96.5Sn/3.0Ag/0.5Cu 焊料 ,或者采用 Sn 含量不超过 97%的锡合金焊料。 Solder: It is recommended to use 96.5Sn/3.0Ag/0.5Cu solder, or use Tin alloy solder with a Tin content not exceeding 97%.

(b) 助焊剂 : 推荐使用松香类助焊剂, 请勿使用强酸性助焊剂 (含氯量超过 0.2wt %), 并且请勿使用水溶性助焊剂。

Flux: It is recommended to use rosin-based flux. Acidic flux (with chlorine content exceeding 0.2wt %) and water-soluble flux are forbidden.

• 焊接温度及要求 Soldering Temperature & Requirements

回流焊温度曲线 Reflow Soldering Temperature Profile

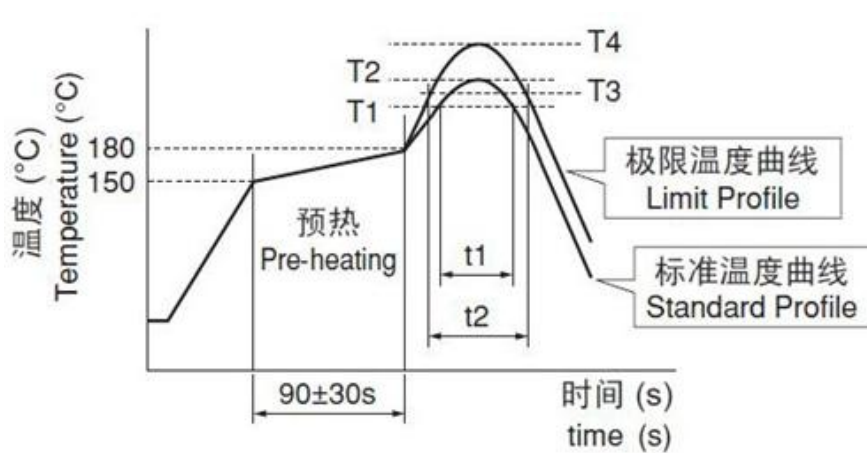

回流焊要求 Reflow Soldering Requirements

标准温度曲线Standard Profile				极限温度曲线Limit Profile			
加热Heating		峰值温度 Peak Temp. (T2)	回流焊 次Cycle Of Reflow	加热Heating		峰值温度 Peak Temp. (T4)	回流焊次数 Cycle Of Reflow
加热 Temp. (T1)	时间 Ti me (t1)			温度 Temp. (T3)	时间 Time (t2)		
220°C	30~60s	245±3°C	≤2	230°C	≤60s	260°C/10s	1

6、其他

- ◆ 本产品为无铅, 请采用无铅环境作业
- ◆ Other: Our company's products are lead-free, please operate in a lead-free environment
- ◆ 由于页面限制, 更多资料请联系我司
- ◆ Due to page limitations, please contact our company for more information
- ◆ 在过载电流等不正常条件下, 本电感产品无自我保护功能。
- ◆ Under abnormal conditions such as overload current, this inductor product has no self-protection function.
- ◆ 产品储存期不建议超过 12 个月
- ◆ The storage period of the product is not recommended to exceed 12 months